

A2

Slotted pan head
tapping screws, stainless steel

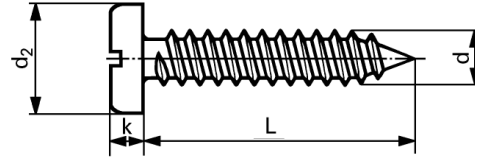

DIN 7971 C cone point

ISO 1481

d	2,2 ISO 2		2,9 ISO 4		3,5 ISO 6		3,9 ISO 7	
d2	4,2		5,6		6,9		7,5	
k	1,35		1,75		2,1		2,25	
L	quantity		100	1000+	100	1000+	100	1000+
4,5	15.-	12.50						
6,5	13.50	10.20	8.20	6.-	8.70	6.40	10.50	8.20
9,5	15.30	12.60	7.50	5.40	7.90	5.80	9.10	6.70
13	15.50	12.80	7.60	5.50	7.90	5.90	9.30	6.80
16			8.40	5.90	8.50	6.-	10.40	7.60
19			8.50	6.-	9.10	6.70	11.10	8.10
22			12.30	9.-	12.60	9.20	13.60	10.-
25			12.50	9.20	12.80	9.50	15.-	11.40
32					14.40	10.90	17.40	13.30
38					16.10	12.20	19.50	15.75

d	4,2 ISO 8		4,8 ISO 10		5,5 ISO 12		6,3 ISO 14	
d2	8,2		9,5		10,8		12,5	
k	2,45		2,8		3,2		3,65	
L	quantity		100	1000+	100	1000+	100	1000+
9,5	9.50	6.90	12.80	9.40			30.80	24.50
13	9.50	6.90	12.80	9.40	19.-	14.50	29.-	23.-
16	10.50	7.70	13.60	10.30	21.-	16.10	27.-	21.50
19	11.60	8.50	14.80	11.30	22.50	17.20	28.50	22.50
22	13.95	10.25	16.20	12.30	25.25	20.-	34.75	27.50
25	16.10	12.30	17.40	13.30	26.25	20.75	37.-	29.50
32	19.60	14.90	22.25	16.90	31.-	24.75	47.-	37.50
38	19.80	15.10	25.50	19.50	34.-	27.-	48.-	38.60
45	29.-	23.65	28.25	22.25	39.25	31.25	58.-	47.20
50	31.50	25.70	30.50	24.25	45.-	36.-	72.-	61.30

+ 10% discount for 10 000 pieces per item
Type F upon request

Maryland Metrics Fastener Catalog - Chapter E Owings Mills, MD 21117 USA

phones: (410)358-3130 (800)638-1830 faxes: (410)358-3142 (800)872-9329 e-mail: techinfo@mdmetric.com
copyright 2003 maryland metrics/kyburz ch

A2

Slotted flat head
tapping screws, stainless steel

DIN 7972 C cone point

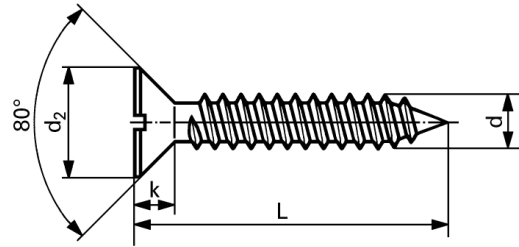

ISO 1482

d	2,9 ISO 4		3,5 ISO 6		(3,9) ISO 7	
d2	5,5		6,8		7,5	
k	≈ 1,7		2,1		2,3	
L quantity	100	1000+	100	1000+	100	1000+
6,5	7.50	5.80	8.50	6.20	13.40	10.20
9,5	7.50	5.80	8.50	6.20	9.60	7.10
13	8.20	6.40	9.–	6.70	10.–	7.30
16	8.50	6.60	9.20	6.90	10.70	7.80
19	8.50	6.80	9.60	7.10	10.90	8.–
22	10.70	8.90	11.70	10.20	13.90	11.60
25	15.30	11.60	12.20	10.60	14.70	12.50
32			15.10	12.50	18.20	13.90
38			17.–	13.80	19.60	14.90

d	4,2 ISO 8		4,8 ISO 10		(5,5) ISO 12		6,3 ISO 14
d2	8,1		9,5		10,8		12,4
k	≈ 2,5		3		3,4		3,8
L quantity	100	1000+	100	1000+	100	1000+	100
9,5	9.30	6.80	13.20	9.70			
13	9.30	6.80	13.50	10.30	33.25	26.25	30.–
16	10.10	7.40	14.90	11.40	25.75	20.50	30.–
19	10.50	7.70	15.80	12.10	26.75	21.25	30.–
22	13.50	10.30	16.70	12.80	27.50	22.–	35.–
25	14.70	11.20	17.80	13.60	28.50	22.50	37.50
32	17.50	14.45	22.–	16.70	30.25	24.–	43.–
38	19.–	15.90	25.25	19.20	32.75	26.–	46.50
45	25.–	19.–	28.75	23.–			
50	29.–	23.–	31.–	24.50			

+ 10% discount for 10 000 pieces per item
Type F upon request

Maryland Metrics Fastener Catalog - Chapter E Owings Mills, MD 21117 USA

phones: (410)358-3130 (800)638-1830 faxes: (410)358-3142 (800)872-9329 e-mail: techinfo@mdmetric.com
copyright 2003 maryland metrics/kyburz ch

A2

Slotted oval head
tapping screws, stainless steel

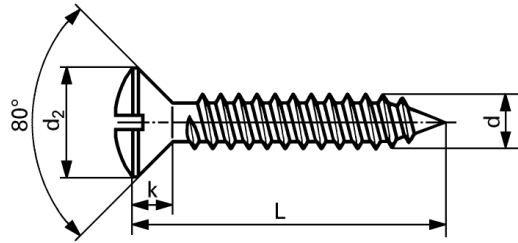

DIN 7973 C cone point

ISO 1483

d	2,9 ISO 4		3,5 ISO 6		(3,9) ISO 7	
d2	5,5		6,8		7,5	
k ≈	1,7		2,1		2,3	
L quantity	100	1000+	100	1000+	100	1000+
6,5	13.10	9.60	9.–	6.60		
9,5	7.80	5.50	8.–	5.90	9.80	7.20
13	7.80	5.70	8.20	6.–	10.10	7.40
16	8.30	6.10	8.50	6.20	10.90	8.–
19	8.30	6.10	9.50	6.90	11.20	8.20
22	13.20	9.70	13.50	9.90	14.–	10.70
25			14.70	11.–	15.–	11.40
32			14.90	11.40	18.10	13.80
38			18.50	15.20	20.–	16.40

d	4,2 ISO 8		4,8 ISO 10		(5,5) ISO 12		6,3 ISO 14	
d2	8,1		9,5		10,8		12,4	
k ≈	2,5		3		3,4		3,8	
L quantity	100	1000+	100	1000+	100	1000+	100	1000+
9,5	11.70	8.60	13.40	10.40				
13	10.20	7.50	13.20	10.10	21.–	16.10	28.50	22.50
16	10.50	7.70	13.60	10.30	25.–	19.–	28.50	22.50
19	12.70	9.30	15.–	11.40	25.75	20.50	32.–	25.50
22	14.20	10.80	16.40	12.50	27.50	22.–	35.25	28.–
25	15.10	11.80	17.60	13.40	28.50	22.50	42.50	33.75
32	18.–	14.–	22.25	16.90	31.–	24.75	51.50	41.–
38	22.–	17.10	25.50	19.50	35.50	28.25	57.–	45.50
45	27.50	22.–	29.75	23.50	44.–	34.75	62.–	50.40
50			34.–	27.–			68.50	56.70

+ 10% discount for 10 000 pieces per item
Type F upon request

Maryland Metrics Fastener Catalog - Chapter E Owings Mills, MD 21117 USA

phones: (410)358-3130 (800)638-1830 faxes: (410)358-3142 (800)872-9329 e-mail: techinfo@mdmetric.com
copyright 2003 maryland metrics/kyburz ch

A2

Hex head tapping screws
stainless steel

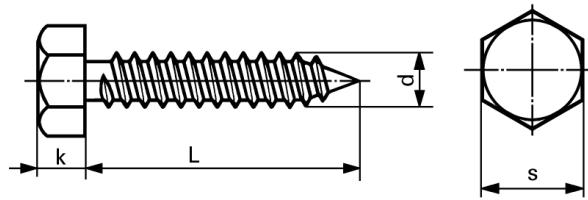

DIN 7976 C cone point

ISO 1479

d	3,5 ISO 6		(3,9) ISO 7	
s	5,5		7	
k	2,3		2,3	
L quantity	100	1000+	100	1000+
9,5	19.10	15.30	22.25	17.90
13	19.30	15.40	22.50	18.10
16	20.50	16.30	23.-	18.50
19	22.75	18.20		
22	26.-	21.75		
25	29.50	24.75		
32	35.75	30.-		

d	4,2 ISO 8		4,8 ISO 10		(5,5) ISO 12		6,3 ISO 14	
s	7		8		8		10	
k	2,8		3		4		4,8	
L quantity	100	1000+	100	1000+	100	1000+	100	1000+
9,5	24.50	19.50						
13	24.-	19.20	29.-	24.-			59.50	49.50
16	24.75	19.80	31.50	26.25	47.50	39.25	59.50	49.50
19	26.-	21.75	33.25	27.75	50.50	42.-	63.-	53.-
22	33.-	27.50	36.75	30.75	58.-	48.50	69.-	60.-
25	34.-	28.25	40.50	33.50	63.-	52.50	73.50	64.-
32	41.50	34.25	50.50	42.-			82.-	71.-
38							91.50	79.50
45							102.-	88.-
50							110.-	95.50

+ 10% discount for 10 000 pieces per item
Type F upon request

Maryland Metrics Fastener Catalog - Chapter E Owings Mills, MD 21117 USA

phones: (410)358-3130 (800)638-1830 faxes: (410)358-3142 (800)872-9329 e-mail: techinfo@mdmetric.com
copyright 2003 maryland metrics/kyburz ch

A2

Front panel screws
Hex head tapping screws
stainless steel
with assembled washer
(OD = 16 mm)
and Neoprene seal

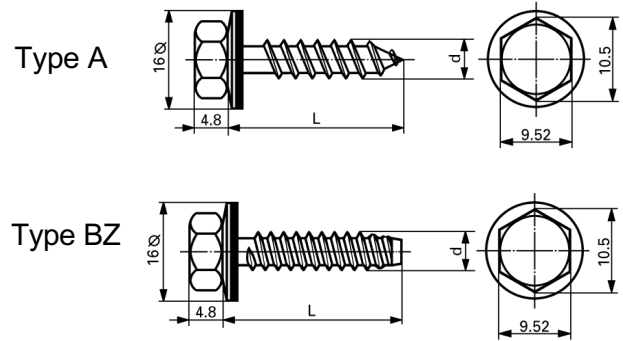

K 576

		Type BZ		Type A	
		fine pitch		coarse pitch	
		6,3		6,5	
d	quantity	100	1000	100	1000
16		74.50	54.-	74.50	54.-
19		77.-	55.50	77.-	55.50
25		86.50	63.-	86.50	63.-
32		97.50	70.50	96.-	68.50
38		112.-	81.-	111.-	80.50
45		118.-	85.50	117.-	84.50
50		127.-	91.50	125.-	90.50
64		153.-	116.-	148.-	112.-
80		160.-	125.-		
90		192.-	145.-	186.-	140.-
100		218.-	164.-	211.-	159.-
115		245.-	184.-	235.-	178.-
130		284.-	215.-	274.-	207.-
150		310.-	234.-	302.-	228.-
175		380.-	286.-	380.-	286.-
200		485.-	366.-	470.-	356.-

Larger washers upon request

A2

Cross recessed pan head tapping screws, stainless steel type H (Phillips)

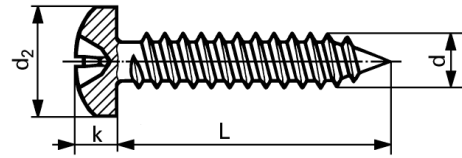

DIN 7981 C cone point

ISO 7049

d	2,2 ISO 2		2,9 ISO 4		3,5 ISO 6		(3,9) ISO 7	
d2	4,2		5,6		6,9		7,5	
k	18		2,2		2,6		2,8	
L quantity	100	1000+	100	1000+	100	1000+	100	1000+
6,5	12.50	10.20	7.50	5.80	9.10	6.30	10.60	7.40
9,5			7.70	5.90	8.10 ●	6.10	9.40 ●	6.60
13	14.-	11.50	7.80 ●	6.-	8.40 ●	6.20	9.70	6.80
16	15.50	12.20	8.40	6.60	8.60	6.70	10.70	7.50
19			9.60	7.40	9.80	7.50	11.20 ●	7.80
22			10.20	8.-	11.50	8.10	14.-	9.80
25			11.80	9.60	12.-	9.80	14.60	10.60
32					15.10	11.-	18.10	13.20
38					18.20	13.30	22.-	15.90

d	4,2 ISO 8		4,8 ISO 10		(5,5) ISO 12		6,3 ISO 14	
d2	8,2		9,5		10,8		12,5	
k	3,05		3,55		3,95		4,55	
L quantity	100	1000+	100	1000+	100	1000+	100	1000+
9,5	9.90 ●	6.90	13.40	9.30				
13	10.50 ●	7.30	13.70 ●	9.60	20.50	15.-	27.-	19.70
16	10.90 ●	7.60	14.40	10.50	22.75	16.50	27.-	20.50
19	12.- ●	8.40	15.90	11.50	25.-	18.10	31.25	23.75
22	14.10	10.30	17.30	12.60	26.50	20.25	35.-	26.50
25	15.90	11.50	20.25	14.80	28.25	21.50	38.-	28.75
32	17.60	12.80	23.25	16.80	33.50	25.50	44.50	33.50
38	22.-	16.80	26.50	19.40	37.25	28.25	49.50	37.50
45	23.25	17.50	31.25	23.50	42.50	32.-	55.50	42.-
50	26.50	19.40	32.75	24.75	46.-	34.50	61.-	46.50
60	33.-	28.50	40.50	33.50	51.50	39.50		
70					57.-	43.50	72.-	57.70

+ 10% discount for 10 000 pieces per item

● Type F in stock / 25% surcharge

Maryland Metrics Fastener Catalog - Chapter E Owings Mills, MD 21117 USA

phones: (410)358-3130 (800)638-1830 faxes: (410)358-3142 (800)872-9329 e-mail: techinfo@mdmetric.com
copyright 2003 maryland metrics/kyburz ch

A2

Cross recessed flat head tapping screws, stainless steel type H (Phillips)

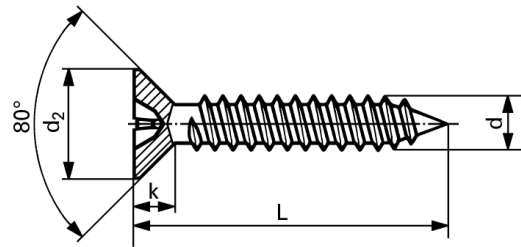

DIN 7982 C cone point

ISO 7050

d	2,9 ISO 4		3,5 ISO 6		(3,9) ISO 7	
d2	5,5		6,8		7,5	
k	≈ 1,7		2,1		2,3	
L quantity	100	1000+	100	1000+	100	1000+
6,5	11.70	8.20	12.80	9.30	14.50	11.60
9,5	11.80	8.30	12.80	9.30	13.20	9.50
13	12.–	8.50	13.–	9.50	13.50	9.70
16	12.20	8.70	13.50	10.10	15.50	11.20
19	13.–	9.–	14.10	10.70	15.80	11.50
22	14.50	10.10	15.20	11.80	18.–	12.60
25	14.70	10.30	17.35	13.40	19.20	14.40
32			20.50	15.40	25.–	17.50
38			25.–	18.80	28.25	19.80
45			28.–	21.20		

d	4,2 ISO 8		4,8 ISO 10		(5,5) ISO 12		6,3 ISO 14	
d2	8,1		9,5		10,8		12,4	
k	≈ 2,5		3		3,4		3,8	
L quantity	100	1000+	100	1000+	100	1000+	100	1000+
9,5	12.–	8.40	19.40	16.20				
13	13.80	9.70	16.20	11.30	31.–	23.50	40.–	32.25
16	14.50	10.50	17.30	12.10	33.20	25.40	44.–	32.–
19	15.10	11.10	18.80	13.20	34.80	26.10	44.–	32.–
22	19.10	13.95	24.25	16.90	36.60	27.90	48.–	36.–
25	22.–	16.80	27.–	19.80	38.–	29.55	49.50	37.70
32	23.50	18.20	31.–	23.50	40.40	31.80	53.–	42.60
38	25.50	19.50	35.40	27.70	47.20	38.90	58.–	48.90
45	31.80	24.40	36.20	28.55			71.–	52.–
50	38.–	30.20	46.–	38.70	58.–	49.50	79.–	60.50
55	41.50	33.60						
60	43.–	35.50	53.–	45.25			85.–	66.–
70	48.50	39.75	61.–	53.–			92.–	73.–
80	58.–	49.20	68.–	59.80			95.–	76.–

+ 10% discount for 10 000 pieces per item
Type F upon request

Maryland Metrics Fastener Catalog - Chapter E Owings Mills, MD 21117 USA

phones: (410)358-3130 (800)638-1830 faxes: (410)358-3142 (800)872-9329 e-mail: techinfo@mdmetric.com
copyright 2003 maryland metrics/kyburz ch

A2

Cross recessed oval head tapping screws, stainless steel type H (Phillips)

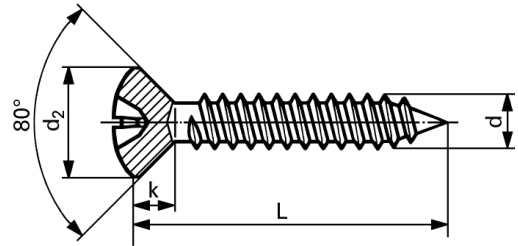

DIN 7983 C cone point

ISO 7051

d	2,9 ISO 4		3,5 ISO 6		(3,9) ISO 7			
d2	5,5		6,8		7,5			
k	≈ 1,7		2,1		2,3			
L	quantity		100	1000+	100	1000+	100	1000+
6,5	10.60	8.20						
9,5	8.80	6.80	9.50	8.–	13.30	10.50		
13	9.20	7.–	10.80	9.30	12.40	9.80		
16	11.20	7.50	11.50	9.70	13.80	10.80		
19	11.70	8.–	12.30	10.60	14.–	11.40		
22	13.30	9.30	13.50	11.50	18.20	12.70		
25	14.80	10.30	15.50	13.20	19.50	13.60		
32			17.10	14.50	22.40	16.70		
38			20.50	17.60	25.10	20.–		

d	4,2 ISO 8		4,8 ISO 10		(5,5) ISO 12		6,3 ISO 14	
d2	8,1		9,5		10,8		12,4	
k	≈ 2,5		3		3,4		3,8	
L	quantity		100	1000+	100	1000+	100	1000+
9,5	15.70	11.–	20.50	17.–				
13	12.80	10.–	17.20	12.–				
16	14.–	10.90	18.30	12.80	28.50	20.75	47.–	34.–
19	14.50	11.80	19.80	13.90	30.50	22.–	47.–	34.–
22	18.50	13.30	25.75	18.–	30.75	22.25	49.50	35.75
25	19.90	14.80	27.–	18.90	33.–	24.–	50.–	36.50
32	23.–	17.10	29.75	21.50	38.–	27.50	56.50	41.50
38	26.–	21.20	34.–	24.75	44.–	31.75	61.–	44.–
45	29.–	24.10	41.50	30.–	50.–	37.50	68.–	51.50
50	35.–	28.90	43.–	31.–	55.–	42.50	71.–	54.–

+ 10% discount for 10 000 pieces per item
Type F upon request

Maryland Metrics Fastener Catalog - Chapter E Owings Mills, MD 21117 USA

phones: (410)358-3130 (800)638-1830 faxes: (410)358-3142 (800)872-9329 e-mail: techinfo@mdmetric.com
copyright 2003 maryland metrics/kyburz ch

A2

Hexalobular socket pan head tapping screws, stainless steel

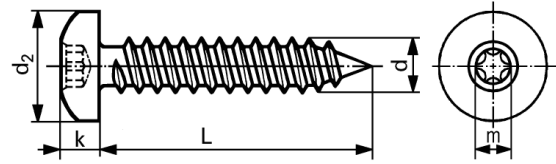

ISO 14585

d	2,9		3,5		4,2		4,8	
d2	5,6		7		8		9,5	
k	≈ 2,4		2,6		3,1		3,7	
m (TX)	T10 (2,8)		T15 (3,35)		T20 (3,95)		T25 (4,5)	
L quantity	100	1000+	100	1000+	100	1000+	100	1000+
9	11.90	7.60	13.30	8.70	17.60	12.-		
13	12.30	7.90	14.50	9.60	20.25	14.10	24.25	17.10
16	12.40	8.-	15.50	10.40	22.-	15.40	25.75	18.20
19	13.20	8.60	16.40	11.10	22.10	15.50	28.-	19.90
22			17.60	12.-	22.75	16.-	30.-	21.50
25					24.50	17.20	31.50	22.75
32					27.50	19.60	35.-	26.25
38							38.25	29.-
45							42.50	32.50
50							45.50	34.75

+ 10% discount for 10 000 pieces per item

A2

Hexalobular socket flat head tapping screws, stainless steel

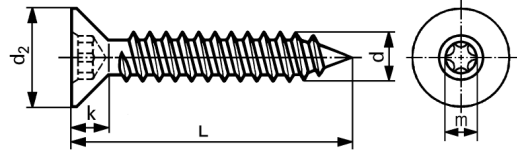

ISO 14586

d	3,5		4,2		4,8		
d2	7,3		8,4		9,3		
k	2,35		2,6		2,8		
m (TX)	T 15 (3,35)		T 20 (3,95)		T 25 (4,5)		
L quantity	100	1000+	100	1000+	100	1000+	
9	14.65	9.60					
13	16.-	10.80					
16	17.20	11.60	24.20	16.95	28.50	20.50	
19	18.-	12.40	24.50	17.20	31.-	22.60	
25	22.50	16.30	27.-	19.-	35.15	25.40	
32	24.80	18.90	32.-	24.40	39.-	28.90	
38			36.50	28.90	42.20	32.30	
45					48.-	37.80	
50					52.-	41.50	

+ 10% discount for 10000 pieces per item