

# POLYAMID 66

Slotted cheese head  
machine screws

ISO 1207 / DIN 84 A

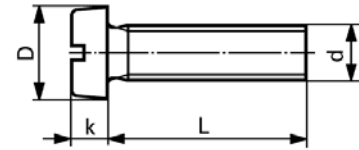

Slotted pan head  
machine screws

ISO 1580 / DIN 85 A

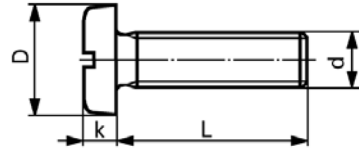

d		M3		M4		M5		M6	M8	M10
L	quantity	100	1000	100	1000	100	1000	100+	100+	100+
4		13.-	8.50							
6		13.-	8.50	13.30	8.70	14.90	9.90			
8		13.-	8.50	13.60	8.90	15.10	10.10	18.10		
10		13.20	8.60	14.-	9.20	15.60	10.50	17.60	31.75	
12		13.20	8.60	14.30	9.40	15.80	10.60	17.90		
16		13.50	8.80	14.60	9.70	17.-	11.60	18.60	33.25	
20		14.20	9.40	15.10	10.10	19.50	13.50	20.25	36.25	64.-
25		14.50	9.60	15.80	10.60	20.50	14.20	22.-	37.75	
30		14.80	9.90	16.60	11.20	21.75	15.20	25.75	40.50	76.50
35				17.50	11.90	23.-	16.10	26.75	44.-	82.50
40				17.80	12.10	24.25	17.10	27.75	46.50	89.-
50						26.25	18.60	29.25	49.50	95.-
60								30.75		
70								36.-		

Dimensions: see steel screws

+ 15% discount for 1000 pieces per item

# POLYAMID 66

Slotted flat head  
machine screws

## DIN 963 A

Slotted oval head  
machine screws

## DIN 964 A

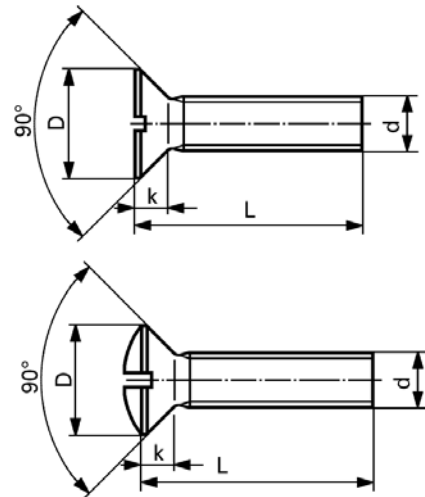

ISO 2009 / ISO 2010

d	M3		M4		M5		M6		M8	
D	5,6		7,5		9,2		11		14,5	
k	1,65		2,2		2,5		3		4	
L	quantity	100	1000	100	1000	100	1000	100	1000	100
6	13.-	8.50	14.30	9.40						
8	13.-	8.50	14.50	9.60	15.70	10.50				
10	13.20	8.60	14.80	9.90	15.80	10.60				
12	13.20	8.60	15.50	10.30	16.30	11.-				
16	13.50	8.80	15.60	10.50	18.30	12.50	19.60	13.60	33.50	
20	14.20	9.40	16.30	11.-	19.90	13.80	22.-	15.40	35.50	
25	15.10	10.10	16.90	11.50	21.-	14.60	24.25	17.20	38.75	
30			17.60	12.-	22.25	15.60	26.-	18.50	43.50	
35			18.60	12.80	23.75	16.80	27.75	19.80	48.-	
40					24.75	17.40	31.75	22.75	50.-	
50							33.50	24.25	55.50	
60							34.-	25.50	62.-	

## A2

Slotted cheese head  
machine screws, stainless steel

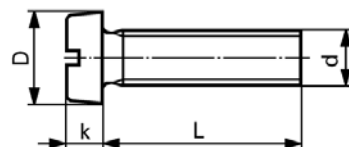

## ISO 1207 / DIN 84 A

d	M 1,6	M 2		M 2,5		M 3		M 3,5	
D	3	3,8		4,5		5,5		6	
k	1 ISO 1,1	1,3 ISO 1,4		1,6 ISO 1,8		2		2,4	
L quantity	100	100	1000+	100	1000+	100	1000+	100	100
3	23.-	7.-	3.85						
4		6.-	2.95	6.-	3.70	6.-	3.55		
5	18.-	6.70	3.60	6.-	4.-	6.-	3.75	7.50	4.30
6	20.75	6.70	3.60	6.-	4.-	6.-	3.-		
8	22.-	6.-	3.10	6.-	3.35	6.-	3.15		
10		6.-	3.20	6.-	3.70	6.-	3.35	8.-	4.60
12		6.-	3.35	6.-	3.70	6.-	3.65	8.50	5.-
(14)	25.-			8.40	4.60	7.-	5.10		
16		6.60	3.70	8.-	4.30	6.-	4.-		
(18)						7.20	5.70		
20		7.10	4.30	8.60	6.60	6.50	4.60	14.20	9.40
25				10.10	7.40	7.20	5.70	16.-	11.40
30						8.40	6.20	17.50	13.10
35						9.80	7.70		
40						11.90	9.20		
45						12.50	10.80		
50						14.50	12.10		
60						18.80	16.50		

+ 10% discount for 10 000 pieces per item

## A2

Slotted cheese head  
machine screws, stainless steel

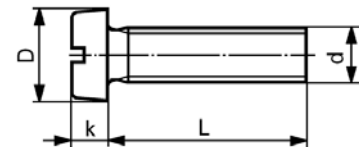

## ISO 1207 / DIN 84 A

d	M 4		M5		M6		M8		M 10	
D	7		8,5		10		13		16	
k	2,6		3,3		3,9		5		6	
L	quantity	100	1000+	100	1000+	100	1000+	100	1000+	100
5		8.-	5.70							
6		7.10	5.10	12.90	10.30					
8		6.40	4.70	9.90	7.60	14.40	11.50			
10		7.10	5.10	11.70	8.20	14.40	11.50	35.-	28.-	
12		7.40	5.40	12.-	8.60	14.70	11.80	36.-	29.25	
(14)		9.-	6.90	12.70	10.10	16.30	13.10	38.20	31.10	
16		8.20	6.20	12.90	10.30	15.50	12.30	39.-	32.40	
(18)		10.50	7.30	15.40	13.10	19.70	15.-			
20		9.10	7.-	14.-	11.20	17.30	13.80	41.-	34.-	68.50
(22)				16.50	13.70					
25		10.40	8.-	15.90	12.80	19.70	15.70	43.-	36.-	72.-
30		12.-	9.20	18.-	14.40	21.75	17.40	48.50	40.50	78.50
35		14.20	11.30	20.25	16.-	24.25	20.25	56.-	46.50	86.50
40		18.20	14.60	22.-	17.60	28.25	23.50	60.-	52.-	96.-
45		23.-	18.30	27.75	23.-	33.50	27.75	72.50	63.-	
50		26.-	21.50	33.-	27.50	39.-	33.10	73.50	64.-	132.-
(55)				38.-	32.80	56.50	49.-	88.50	76.-	
60		36.25	27.75	56.50	49.-	62.-	54.-	90.50	78.50	172.-
70		38.50	29.60	61.50	54.-	69.-	56.50	105.-	90.-	191.-
80				75.-	65.-	74.-	61.50	117.-	102.-	256.-
90				78.-	68.-			147.-	122.-	
100								164.-	141.-	338.-

+ 10% discount for 10 000 pieces per item

**Maryland Metrics Fastener Catalog - Chapter G** Owings Mills, MD 21117 USA

phones: (410)358-3130 (800)638-1830 faxes: (410)358-3142 (800)872-9329 e-mail: techinfo@mdmetric.com  
copyright 2003 maryland metrics/kyburz.ch

## A4

Slotted cheese head  
machine screws, stainless steel

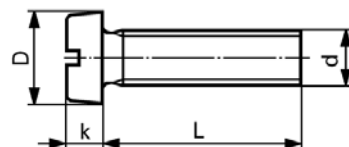

## ISO 1207 / DIN 84 A

d	M2		M2,5		M3		M4	
D	3,8		4,5		5,5		7	
k	1,3 ISO 1,4		1,6 ISO 1,8		2		2,6	
L quantity	100	1000+	100	1000+	100	1000+	100	1000+
4	7.80	4.50	8.20	4.80				
5	7.90	4.60	8.50	5.-	8.20	5.10	12.30	9.30
6	8.-	4.70	8.60	5.10	8.20	5.10	10.-	7.-
8	8.20	4.80	8.80	5.30	8.30	5.20	9.50	6.60
10	8.60	5.10	8.80	5.30	8.30	5.20	10.30	7.20
12	8.90	5.30	9.-	5.50	8.50	5.40	10.90	7.70
(14)					10.20	7.10	14.10	10.30
16	9.-	5.40	9.20	5.70	8.80	5.80	12.50	8.70
(18)					11.50	8.10	15.90	11.60
20	10.10	6.60	15.90	12.60	9.30	6.50	13.60	9.90
25			24.25	17.20	10.80	7.50	15.40	11.10
30					13.60	9.90	18.-	13.20
35					19.70	14.30	24.50	17.80
40					25.50	19.30	29.25	22.-
45					57.-	43.-		
50							42.-	31.75
60							45.50	34.50

+ 10% discount for 10 000 pieces per item

## A4

Slotted cheese head  
machine screws, stainless steel

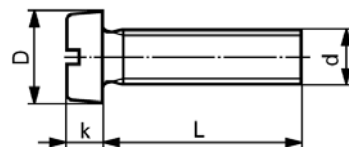

## ISO 1207 / DIN 84 A

d	M5		M6		M8		M10	
D	8,5		10		13		16	
k	3,3		3,9		5		6	
L quantity	100	1000+	100	1000+	100	1000+	100	
6	19.90	13.80						
8	14.90	10.80	23.75	17.30				
10	15.70	11.40	22.25	16.20				
12	16.60	12.10	22.25	16.20	62.-	47.50		
(14)	20.-	14.60	26.25	22.25				
16	19.40	14.10	24.-	17.40	55.-	42.-	114.-	
(18)	23.25	16.80	31.75	24.-				
20	21.75	15.80	25.50	19.30	57.50	43.50	95.-	
25	24.75	18.-	29.25	22.-	61.50	47.-	101.-	
30	26.50	20.25	33.-	25.-	68.-	54.-	108.-	
35	29.75	22.50	40.50	30.75	79.50	63.-	119.-	
40	34.75	26.50	47.-	35.50	86.50	68.-	132.-	
45	42.50	32.25			96.-	78.-		
50	45.50	34.50	62.50	49.50	117.-	92.-	186.-	
60	77.50	61.-	78.50	68.50	137.-	111.-	242.-	
80	82.-	65.-					360.-	

+ 10% discount for 10 000 pieces per item

## A2

Slotted pan head  
machine screws, stainless  
steel

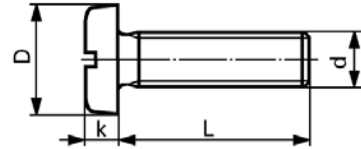

## ISO 1580 / DIN 85 A

d	M 2		M 2,5		M 3		M 4		
D	3,8		5		6 ISO 5,6		8		
k	1,4		1,5		1,8		2,4		
L	quantity	100	1000+	100	1000+	100	1000+	100	1000+
3		8.30	4.80						
4		8.50	5.-	8.-	5.-	10.10	6.90		
5						9.40	5.70		
6				8.-	5.20	6.-	4.-	7.10	5.-
8				9.20	6.30	6.-	4.-	8.20	5.70
10				9.60	6.90	6.-	4.50	7.90	5.40
12		8.80	5.50	9.80	7.10	6.50	5.-	8.20	5.70
(14)						7.10	5.30	10.80	7.50
16						6.50	5.-	8.90	6.20
(18)						10.20	8.50	12.20	10.50
20						7.30	5.50	10.50	7.30
25						8.-	6.60	10.90	8.80
30						9.50	7.50	13.80	10.10
35						12.50	10.80	18.60	14.50
40								24.50	20.50
45								25.70	21.-

+ 10% discount for 10 000 pieces per item

## A2

Slotted pan head  
machine screws, stainless  
steel

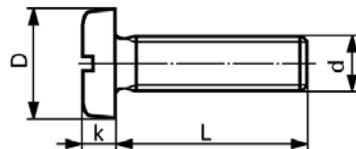

## ISO 1580 / DIN 85 A

d	M5		M6		M8
D	10 ISO 9,5		12		16
k	3		3,6		4,8
L quantity	100	1000+	100	1000+	100
6	10.90	8.80			
8	10.90	8.80	19.30	14.-	
10	11.40	9.20	17.90	13.-	63.50
12	11.60	9.40	17.70	12.80	59.50
(14)	16.20	14.80			
16	12.75	10.30	19.30	14.-	60.50
(18)	17.30	15.90			
20	13.80	11.60	21.25	15.50	60.50
25	16.20	13.20	23.75	17.30	64.-
30	18.85	15.-	26.-	19.70	69.-
35	25.25	19.20	35.50	27.-	78.-
40	29.-	22.-	37.75	28.50	80.-
45	34.75	26.25	43.-	32.50	
50	44.-	33.50	47.50	37.25	93.-
60	54.-	41.-	58.-	44.-	106.-
70	60.-	47.-			
80	72.-	61.-			173.-

+ 10% discount for 10 000 pieces per item

## A4

Slotted pan head  
machine screws, stainless  
steel

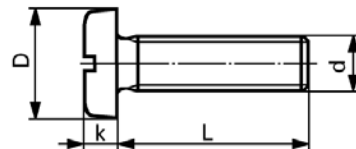

## ISO 1580 / DIN 85 A

d	M 3		M 4		M 5		M 6		M 8
D	6 ISO 5,6		8		10 ISO 9,5		12		16
k	1,8		2,4		3		3,6		4,8
L quantity	100	1000+	100	1000+	100	1000+	100	1000+	100
5	9.20	5.90							
6	7.30	5.10	10.80	7.50	16.20	11.80			
8	7.30	5.10	10.60	7.40	16.20	11.80	27.-	20.50	
10	7.50	5.30	11.20	7.90	17.-	12.40	24.50	17.70	
12	7.70	5.40	11.90	8.40	18.30	13.30	25.25	18.30	
(14)			14.50	11.60			33.50	29.75	
16	8.80	6.10	13.20	9.20	21.-	15.30	27.25	20.75	74.-
(18)	11.10	8.80							
20	9.80	6.80	14.80	10.80	23.50	17.20	30.25	22.75	78.50
25	12.10	9.10	17.-	12.40	25.75	19.60	33.75	25.75	85.-
30	15.40	11.10	19.10	13.90	29.25	22.-	37.25	28.25	90.50
35			25.-	18.10	32.50	24.50	41.50	31.25	99.-
40			35.50	27.-	35.50	27.-	45.50	34.25	104.-
45					50.50	38.-	60.50	48.-	116.-
50					52.50	40.-	79.50	63.-	120.-
60							93.50	74.-	158.-

+ 10% discount for 10 000 pieces per item

## A2

Slotted flat head  
machine screws, stainless steel

## DIN 963 A

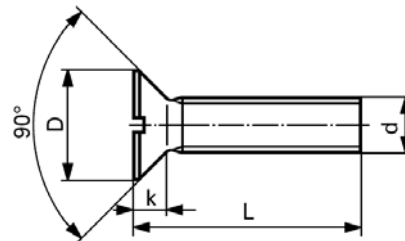

ISO 2009

d	M2		M2,5		M3		M4		
D	3,8		4,7		5,6		7,5		
k	1,2		1,5		1,65		2,2		
L	quantity	100	1000+	100	1000+	100	1000+	100	1000+
4					7.50	5.50			
5		6.50	4.70	7.90	5.70	6.50	4.50		
6		6.-	3.70	6.30	4.20	6.-	3.80	8.30	6.-
8		6.-	4.20	6.30	4.20	6.-	3.50	7.-	5.10
10		6.-	4.20	6.40	4.30	6.-	3.50	6.50	4.80
12		7.10	5.10	6.90	4.60	6.-	3.60	7.10	5.20
(14)						7.60	5.50	10.10	7.30
16		7.20	5.30	7.40	5.40	7.60	5.50	7.80	5.70
(18)						9.10	6.20	10.50	7.60
20		8.50	5.90	8.-	5.50	7.70	5.60	9.-	6.50
(22)						9.50	6.50		
25				12.-	9.60	7.70	5.60	10.50	7.60
30						10.10	7.30	12.20	8.80
35						13.90	10.50	16.70	12.60
40						18.10	13.70	20.75	15.70
45						19.50	15.10	27.-	21.-
50						21.50	17.80	31.25	23.75
60								39.-	33.-

+ 10% discount for 10 000 pieces per item

## A2

Slotted flat head  
machine screws, stainless steel

## DIN 963 A

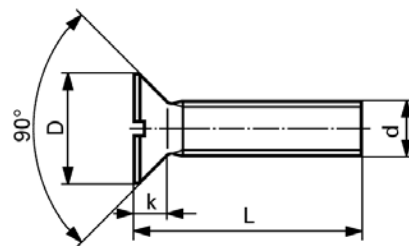

ISO 2009

d	M5		M6		M8		M10	
D	9,2		11		14,5		18	
k	2,5		3		4		5	
L quantity	100	1000+	100	1000+	100	1000+	100	
6	14.50	10.90						
8	9.90	7.10	19.20	14.40				
10	10.20	7.30	14.60	11.-	49.-	43.50		
12	10.50	7.60	14.-	10.60	43.50	37.-		
(14)	13.20	9.70	17.40	12.80				
16	11.90	8.60	14.60	11.-	36.-	28.25	89.50	
(18)	14.80	10.80	20.25	14.70				
20	13.30	10.10	15.60	11.80	37.25	29.25	78.50	
(22)	17.10	12.90						
25	15.60	11.80	18.80	14.20	41.50	32.75	85.50	
30	18.-	13.60	21.75	16.40	47.-	37.-	89.50	
35	20.75	15.60	24.25	18.30	54.-	42.-	99.-	
40	24.25	18.20	30.-	23.50	59.50	46.50	109.-	
45	29.25	23.-	35.-	27.50	67.50	55.-	131.-	
50	37.75	29.75	46.-	36.-	72.50	59.50	137.-	
55	45.-	36.50						
60	55.50	43.50	62.-	49.-	103.-	84.50	179.-	
70	67.50	55.50	65.50	50.-	108.-	92.-	274.-	
80	69.-	57.50	88.-	72.-	139.-	123.-		
90	75.-	63.-	119.-	87.-	149.-	133.-		
100			130.-	110.-				

+ 10% discount for 10 000 pieces per item

## A4

Slotted flat head  
machine screws, stainless steel

## DIN 963 A

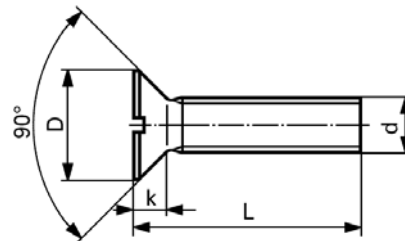

ISO 2009

d	M2		M2,5		M3		M4		
D	3,8		4,7		5,6		7,5		
k	1,2		1,5		1,65		2,2		
L	quantity	100	1000+	100	1000+	100	1000+	100	1000+
4		10.10	7.30						
5		7.20	5.20	7.40	5.40	9.70	7.-		
6		7.20	5.20	7.60	5.50	6.80	4.50	9.20	6.70
8		7.70	5.60	7.90	5.80	6.80	4.50	8.70	6.30
10		8.60	6.20	8.60	6.20	6.80	4.60	8.40	6.10
12		9.-	6.50	9.20	6.80	6.90	4.80	9.30	6.80
(14)						11.-	8.-	12.20	8.80
16		10.20	7.30			7.50	5.50	10.80	7.90
(18)						12.90	9.30	12.90	9.70
20		12.90	9.30			8.40	6.10	12.60	9.10
25						9.90	7.20	14.10	10.70
30						12.60	9.10	16.50	12.50
35						18.70	13.90	18.90	14.20
40						23.25	17.50	23.25	17.50
45								31.50	24.75

+ 10% discount for 10 000 pieces per item

**Maryland Metrics Fastener Catalog - Chapter G** Owings Mills, MD 21117 USA

phones: (410)358-3130 (800)638-1830 faxes: (410)358-3142 (800)872-9329 e-mail: techinfo@mdmetric.com  
copyright 2003 maryland metrics/kyburz.ch

## A4

Slotted flat head  
machine screws, stainless steel

## DIN 963 A

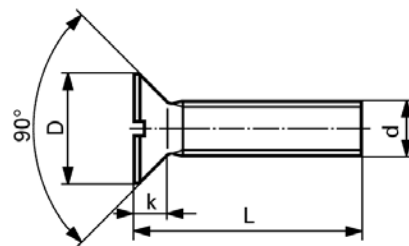

ISO 2009

d	M5		M6		M8		M10	
D	9,2		11		14,5		18	
k	2,5		3		4		5	
L quantity	100	1000+	100	1000+	100	1000+	100	
8	12.60	9.10	24.75	19.50				
10	12.60	9.10	18.10	13.70				
12	13.30	10.10	18.-	13.50	65.-	55.-		
(14)	16.10	12.20	24.25	18.30				
16	16.10	12.20	20.-	15.10	48.50	38.-		
(18)	19.10	14.40						
20	18.50	14.-	22.-	16.50	49.50	39.-	110.-	
25	22.-	16.50	25.50	20.-	55.50	43.50	116.-	
30	25.25	19.10	29.25	23.-	60.-	49.-	122.-	
35	27.50	21.75	32.75	25.75	67.50	55.50	134.-	
40	31.-	24.25	38.50	30.25	74.50	61.-	153.-	
45	40.50	32.-	53.-	41.50	92.50	76.-		
50	44.-	34.75	60.-	47.50	92.50	76.-	193.-	
55							210.-	
60	51.-	42.50	61.50	50.50	119.-	100.-	252.-	
70	68.-	55.-	78.-	63.50	152.-	121.-		
80	75.-	60.-			180.-	149.-		
90	90.-	72.-			190.-	159.-		

+ 10% discount for 10 000 pieces per item