

**CORTE / CUTTING / OUTILS COUPANTS / SCHNEIDWERKZEUG / ARCHETTI /
CORTE / PE3KA**



CORTAVARILLAS BOLT CUTTERS COUPES-BOULONS

Los cortavarillas Ega Master están perfectamente diseñados y fabricados para cortar varillas cilíndricas, varillas de encofrador, mallas de alambre, cables, pernos, etc.

Ega Master bolt cutters are perfectly designed and manufactured for cutting rod, bolts, concrete from ties, cable and wires.

Les coupes-boulons Egamaster sont parfaitement conçus et fabriqués pour la coupe des tiges, des boulons, des câbles et des fils.



1. Sistema multiplicador de par de corte.
Cutting leverage multiplying system.
Accroissement de la coupe par le système multiplicateur.

3. Gran capacidad de corte.
Great cutting capacity.
Capacité de coupe très importante.

4. Mangos ergonómicos y confortables.
Ergonomic and comfortable handles.
Poignées ergonomiques et confortables.

2. El diseño especial reforzado de cabeza permite cortar varillas, pernos, etc. a muy poca distancia de la superficie desde la que sobresalen. El juego de cuchillas está fabricada en cromo-molibdeno, dándole una mayor resistencia y durabilidad gracias a la dureza 62 HRC.

Its strong & specially designed head permits cutting bolts and rods at a very small distance from the surface where they stick out from. Cutting-blades are made in Chrome-Molibdenum, providing a bigger resistance and durability due to their 62 HRC hardness.

Les lames sont fortes et particulièrement conçues pour couper des boulons et sont tiges à une distance très petite de la surface. Les lames de coupe sont faites en Chrome-Molibdenum, fournissant une plus grande résistance et longévité due à leur dureté de 62 HRC.

20

CORTE / CUTTING / OUTILS COUPANTS / SCHNEIDWERKZEUG / ARCHETTI / CORTE / РЕЗКА

CORTAVARILLAS / BOLT CUTTERS / COUPE-BOULONS / BOLZENSCHNEIDER / TAGLIABULLONI / CORTA VARÃO / АРМАТУРНЫЕ НОЖНИЦЫ

A

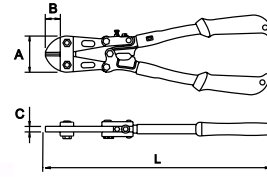

COD ← L → ← A → ← B → ← C →



COD	L	A	B	C	Capacity	Kg	Qty
62193	14"	60	26	7,0	7-5	1,1	2
62194	18"	70	29	8,0	8-6	1,5	
62195	24"	85	33	9,5	10-8	2,4	
62196	30"	95	36	11	13-10	3,7	
62197	36"	110	39	13	16-12	6,0	1
62198	42"	120	43	14	19-14	8,0	
62199	48"	155	60	17	22-16	14	

B

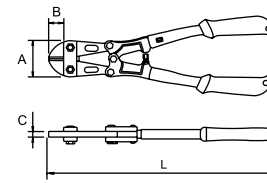

COD ← L → ← A → ← B → ← C →



COD	L	A	B	C	Capacity	Kg	Qty
62201	14"	60	26	7,0	7-5	1,1	2
62202	18"	70	29	8,0	8-6	1,5	
62203	24"	85	33	9,5	10-8	2,4	
62204	30"	95	36	11	13-10	3,7	
62205	36"	110	39	13	16-12	6,0	1
62206	42"	120	43	14	19-14	8,0	

C

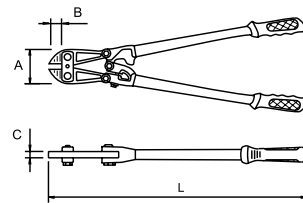

COD ← L → ← A → ← B → ← C →



COD	L	A	B	C	Capacity	Kg	Qty
63293	12"	50	20	6	5-4	0,8	
63294	14"	60	28	7	7-5	1,0	
63295	18"	70	31	8	8-6	1,8	
63296	24"	85	34	9,5	10-8	2,8	1
63297	30"	95	39	11	13-10	4,5	
63298	36"	110	41	13	16-12	6,0	

A	B	C	L
-	-	63782	12"
64096	64056	63783	14"
64097	64057	63784	18"
64098	64058	63785	24"
64099	64059	63786	30"
64100	64060	63787	36"
64101	64061	-	42"



KIT 9 PCS. -COD. A-

PCS.	COD:62191
2	62193 14"
	62194 18"
	62195 24"
	62196 30"
1	62197 36"

KIT 9 PCS. -COD. B-

PCS.	COD:62190
2	62201 14"
	62202 18"
	62203 24"
	62204 30"
1	62205 36"

KIT 9 PCS. -COD. B-

PCS.	COD:62207
2	63294 14"
	63295 18"
	63296 24"
	63297 30"
1	63298 36"



20 CORTE / CUTTING / OUTILS COUPANTS / SCHNEIDWERKZEUG / ARCHETTI / CORTE / РЕЗКА

CORTAVARILLAS / BOLT CUTTERS / COUPE-BOULONS / BOLZENSCHNEIDER / TAGLIABULLONI /
CORTA VARÃO / АРМАТУРНЫЕ НОЖНИЦЫ

MANGOS FORJADOS / FORGED HANDLES / MANCHES FORGÉS / STAHL GESCHMIEDET / MANICI FORGIHTI /
CABOS FORJADOS / КОВАННЫЕ РУКОЯТКИ

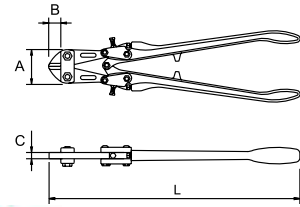

COD	L	A	B	C	CAP HSS 145kg/cm ²	Kg.	
62785	14"	60	26	7	7-5	1,3	
62786	18"	70	32	8	8-6	1,8	
62787	24"	85	34	9,5	10-8	3,2	1
62788	30"	95	39	11	13-10	4,5	
62789	36"	110	43	13	16-12	7,0	



L

64453	14"
64454	18"
64455	24"
64456	30"
64457	36"



KIT 9 PCS.

PCS.	COD:62192
1	62785 14"
2	62786 18"
	62787 24"
	62788 30"
1	62789 36"

HSS MANGOS FORJADOS / FORGED HANDLES / MANCHES FORGÉS / STAHL GESCHMIEDET / MANICI
FORGIHTI / CABOS FORJADOS / КОВАННЫЕ РУКОЯТКИ

BOCAS HSS / HSS BLADES / BECS HSS / HSS MESSER / LAMA HSS / БОКАС HSS / ГУБКИ ИЗ БЫСТРОРЕЖУЩЕЙ СТАЛИ

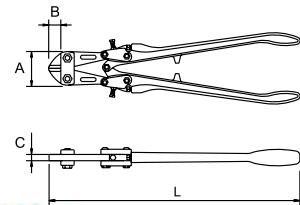

COD	L	A	B	C	HSS	CAP HSS 145kg/cm ²	Kg.	
62808	18"	70	32	8,0		8-6	1,8	
62809	24"	85	34	9,5		10-8	3,2	
62810	30"	95	39	11		13-10	4,5	1
62811	36"	110	43	13		16-12	7,0	



L

64684	HSS	18"
64685		24"
64686		30"
64687		36"



Capaz de cortar varilla hasta 500°C
Able to cut bolts up to 500°C
Coupe possible de barres jusqu'à 500°C

20 CORTE / CUTTING / OUTILS COUPANTS / SCHNEIDWERKZEUG / ARCHETTI / CORTE / РЕЗКА

MANGOS DE ALUMINIO / ALLUMINIUM HANDLES / MANCHES EN ALUMINIUM / ALU GRIFFE / MANICO IN ALLUMINIO / CABO DE ALUMÍNIO / АЛЮМИНИЕВЫЕ РУКОЯТКИ

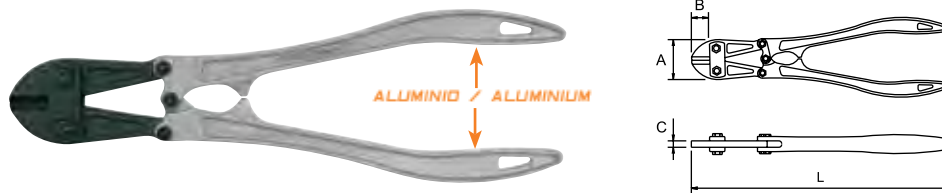

COD	L	A	B	C	CAP 55Kp/mm ² 140Kp/mm ²	Kg.	
62798	12"	50	20	6,0	3-5	0,4	6
62799	14"	60	26	7,0	7-5	0,6	
62800	18"	70	32	8,0	8-6	1,0	1

	L
64667	12"
64453	14"
64454	18"

CORTAVARILLAS FILO ANGULAR / ANGULAR EDGE BOLT CUTTERS / COUPE BOULON MACHOIRE COURBE /
ECKRAND BOLZENSCHNEIDER / TAGLIABULLONI FILO ANGOLARE / CORTA VARÃO DE FIO ANGULAR /
АРМАТУРНЫЕ НОЖНИЦЫ С РЕГУЛИРОВКОЙ



COD	L	A	B	C	CAP 55Kp/mm ² 140Kp/mm ²	Kg.	
62813	18"	70	29	8	8-6	1,8	1
62814	24"	85	33	9,5	10-8	2,6	

	L
64689	18"
64690	24"

CORTAVARILLAS / BOLT CUTTERS / COUPE-BOULONS / BOLZENSCHNEIDER / TAGLIABULLONI / CORTA VARÃO /
АРМАТУРНЫЕ НОЖНИЦЫ



COD	L	A	B	C	CAP 140Kp/mm ²	Kg.		
62200	8"	39	16	4,5	3	0,3	6	1

20 CORTE / CUTTING / OUTILS COUPANTS / SCHNEIDWERKZEUG / ARCHETTI / CORTE / РЕЗКА

CORTAVARILLAS DE MESA / BOLT CUTTER BENCH TYPE / COUPE-BOULONS HORIZONTAL /
TISCHBOLZENSCHNEIDER / TAGLIABULLONI DA BANCO / CORTA VARÃO DE BANCADA /
ВЕРСТАЧНЫЕ АРМАТУРНЫЕ НОЖНИЦЫ

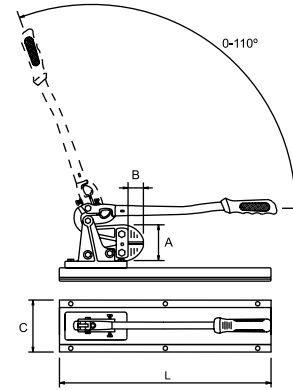

COD	L	A	B	C	CAP 30Kg/160lb	Kg.	
62513	24"	85	34	135	10-8	5,5	1

64334	24"
-------	-----

CORTAVARILLAS BOCA PELICANO / PELICAN BOLT CUTTER / COUPE-BOULONS "BEC PELICAN" /
BOLZENSCHNEIDER MAULSCHLÜSSEL / TAGLIABULLONI / TESOURA CORTA VARÃO BOCA PELICANO /
АРМАТУРНЫЕ НОЖНИЦЫ «ПЕЛИКАН»

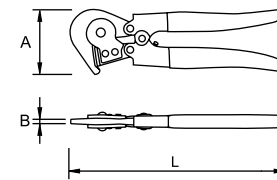

COD	L	A	B	CAP 30Kg/160lb	Kg.	
62903	9"	70	6	5	0,3	1

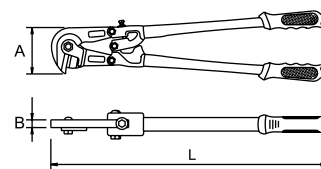

COD	L	A	B	CAP 30Kg/160lb	Kg.	
62514	24"	100	9,5	9-7	2,7	1

64335	24"
-------	-----

20 CORTE / CUTTING / OUTILS COUPANTS / SCHNEIDWERKZEUG / ARCHETTI / CORTE / РЕЗКА

CORTACABLES DE ACERO / WIRE ROPE CUTTER / COUPE CÂBLES / STAHLDRAHT BOLZENSCHNEIDER / CESCOIA PER CAVI / TESOURA CORTA CABOS DE AÇO / КАБЕЛЕРЕЗЫ

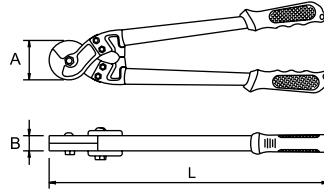

COD	L	A	B	CAP 50Kg/mm ²	Kg.	
62515	18"	65	8,0	12	1,7	1
62516	32"	90	9,0	16	3,6	

	L
64331	18"
64332	32"

CORTACABLES DE ACERO REFORZADO / H.D. WIRE ROPE CUTTER / COUPE CABLES EN ACIER RENFORCÉ / VERSTÄRKTER STAHLDRAHT BOLZENSCHNEIDER / CESCOIA PER CAVI / TESOURA CORTA CABOS DE AÇO REFORÇADO / УСИЛЕННЫЕ КАБЕЛЕРЕЗЫ

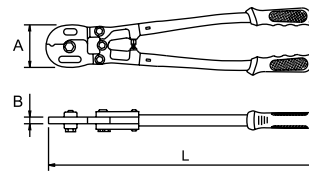

COD	L	A	B	CAP 50Kg/mm ² 143Kg/mm ²	Kg.	
62517	24"	90	9,5	14-10	2,4	1
62518	36"	105	13	18-12	4,7	
62519	42"	120	15	22-13	8,0	

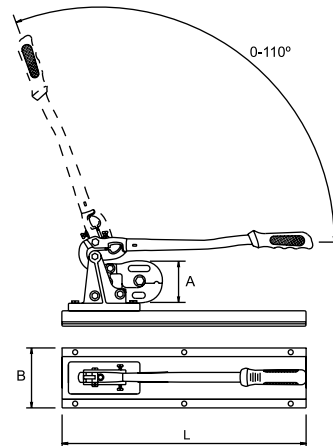

COD	L	A	B	CAP 50Kg/mm ² 143Kg/mm ²	Kg.	
62520	24"	90	135	10-8	5,5	1

	L
64328	24"
64329	36"
64330	42"

20 CORTE / CUTTING / OUTILS COUPANTS / SCHNEIDWERKZEUG / ARCHETTI / CORTE / РЕЗКА

TENAZA DE ENGASTAR / SWAGING TOOL / PINCE À SERTIR / KABELKLEMMZANGE / PINZA PER CAPICORDA /
TURQUES DE ENGASTAR / ОПРЕССОВОЧНЫЙ ИНСТРУМЕНТ



COD	L	A	B	CAP	Kg.	
62521	24"	85	12	1,5-6mm	2,5	1



COD	L	A	B	C	CAP	Kg.	
62522	24"	85	80	135	1,5-6mm	6,0	1

nº1	nº2	nº3	nº4	nº5
Ø1,5 (2,35mm²) Ø2 (3,14mm²)	Ø2,5 (4,90mm²) Ø2,8 (6,15mm²)	Ø3(7,06mm²) Ø3,5 (9,62mm²)	Ø4(12,56mm²)	Ø5(19,63mm²)

Para / for / pour:



	L
64333	24"



La más galardonada
The most awarded
La plus primée

20 CORTE / CUTTING / OUTILS COUPANTS / SCHNEIDWERKZEUG / ARCHETTI / CORTE / PE3KA

ARCO DE SIERRA / HACK SAW / MONTURE DE SCIE À METAUX / METALLSÄGEBOGEN /
ARCHETTI / ARCOS DE SERRA / НОЖОВКА

KRONOS

45° & 90°

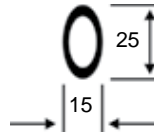

COD			
63742	12"-300mm	900	3



ALU

APOLO II

45° & 90°

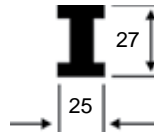

COD			
63781	12"-300mm	750	3



ALU

EFESTO

45° & 90°

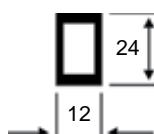

COD			
63304	12"-300mm	750	3



ALU

HÉRCULES

45° & 90°

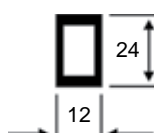

COD			
63748	12"-300mm	600	3



ALU

ULISES

45° & 90°

COD			
63747	12"-300mm	550	3

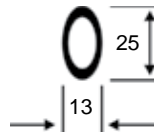

ALU + ABS

TITÁN

90° & 180°

COD			
63745	12"-300mm	450	6

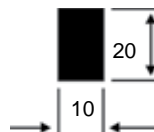

ACERO / STEEL / ACIER

20

CORTE / CUTTING / OUTILS COUPANTS / SCHNEIDWERKZEUG / ARCHETTI / CORTE / РЕЗКА

MINIPROF 90°

COD	Length	TPI	Weight
63744	6"-150mm	260	6

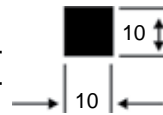

MINICUT 90° & 180°

COD	Length	TPI	Weight
63743	6"-150mm	250	6

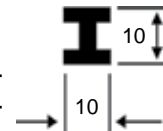

HOJAS DE SIERRA / HACK SAW BLADES / LAMES DE SCIES / METALLSÄGEBLÄTTER / LAME PER ARCHETTI / FOLHA DE SERRA / ПОЛОТНА ДЛЯ НОЖОВКИ

ACERO AL CARBONO / CARBON STEEL / ACIER AU CARBONE

COD	Length	TPI	Weight
64433	12"	14	100
64434		18	
64435		24	
64436		32	



HSS-BIMETAL

COD	Length	TPI	Weight
64437	12"	14	100
64438		18	
64439		24	
64440		32	



IRROMPIBLE / UNBREAKABLE / INDÉCHIRABLE

HSS-BIMETAL (COBALT)

COD	Length	TPI	Weight
64441	12"	14	100
64442		18	
64443		24	
64444		32	



IRROMPIBLE / UNBREAKABLE / INDÉCHIRABLE

ACERO ESPECIAL TEMPLADO / HARDENED SPECIAL STEEL / ACIER TREMPÉ SPÉCIAL / GEHÄRTET SPEZIAL STAHL / ACCIAIO SPECIALE TEMPRATO / AÇO ESPECIAL TEMPERADO / СПЕЦИАЛЬНО ЗАКАЛЕННАЯ СТАЛЬ

COD	Length	TPI	Weight	Blister
63771	6"	24	30	6



SIERRA PARA PVC/ABS / PVC/ABS CUTTING SAW / SCIE À PVC / SÄGE FÜR PVC/ABS / SEGHETTO PER PVC/ABS / SERRA PARA PLÁSTICO / НОЖОВКА ДЛЯ ПЛАСТИКОВЫХ ТРУБ

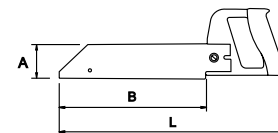

COD	Length	Width	Depth	TPI	Weight
63379	400	64mm	12" (300)	18	300
64458					
64459					

20 CORTE / CUTTING / OUTILS COUPANTS / SCHNEIDWERKZEUG / ARCHETTI / CORTE / РЕЗКА

TIJERAS ARTICULADAS / AVIATION TIN SNIPS / CISAILLE ARTICULÉE / BLECHSCHERE / CESCOIE A DOPPIA LEVA /
TESOURAS ARTICULADAS / НОЖНИЦЫ ДЛЯ ЛИСТОВОГО МЕТАЛЛА

DR

COD	mm	inch.	CAP	gr.		
62169	250	10"	1,2	380	6	1

Cr-V



COD	mm	inch.	CAP	gr.		
62170	250	10"	1,2	380	6	1

Cr-V



COD	mm	inch.	CAP	gr.		
62171	250	10"	1,2	380	6	1

Cr-V



TIJERAS ARTICULADAS REFORZADAS / REINFORCED AVIATION TIN SNIPS / RENFORCÉE CISAILLE ARTICULÉE /
VERSTÄRKT BLECHSCHERE / CESCOIE A DOPPIA LEVA RINFORZATA / TESOURAS ARTICULADAS REFORÇADAS /
УСИЛЕННЫЕ НОЖНИЦЫ ДЛЯ ЛИСТОВОГО МЕТАЛЛА

COD	mm	inch.	CAP	gr.		
62188	250	10"	1,2	470	6	1

Cr-V



COD	mm	inch.	CAP	gr.		
62189	250	10"	1,2	470	6	1

Cr-V



TIJERAS PARA CHAPA / TIN SNIPS / CISAILLES À TOLE / BLECHSCHEREN / CESCOIE PER LAMIERA / TESOURA
PARA CHAPA / НОЖНИЦЫ ДЛЯ ЛИСТОВОГО МЕТАЛЛА

COD	L	CAP	gr.		
62232	8"	0,5	350	6	1
62159	10"	1	550		
62233	12"	1,2	700	4	-
62234	14"		900		



COD	L	CAP	gr.		
62267	8"	0,5	240	6	1
62268	10"	1	490		
62269	12"	1,2	700		
62270	14"		900		



CIZALLA ROEDORA / RATCHET SNIP / BRIGNOTEUSE / NIBBELSCHERE / CESCOIE RODITRICI / TESOURA ROEDORA
НОЖНИЦЫ ДЛЯ ЛИСТОВОГО МЕТАЛЛА С ТРЕЩЕТКОЙ





COD	L	CAP	gr.			
62160	10"	1,2	460	6	1	80075



20





CORTE / CUTTING / OUTILS COUPANTS / SCHNEIDWERKZEUG / ARCHETTI / CORTE / РЕЗКА

CORTADORES DE SEGURIDAD CON CUCHILLA AUTO-RETRACTIL / SAFETY CUTTER WITH AUTO-RETRACTABLE BLADE / CUTTER DE SÉCURITÉ AVEC LAME AUTO-RÉTRACTABLE / SICHERHEITSMESSER MIT AUTOMATISCH EINZIEHBARER KLINGE / TAGLIERINO DI SICUREZZA CON LAMA AUTOMATICA - RETRAIBILE / X-ACTOS DE SEGURANÇA COM LÂMINA AUTO-RETRACTIL / БЕЗОПАСНЫЙ НОЖ С АВТОМАТИЧЕСКИ УБИРАЕМЫМ ЛЕЗВИЕМ

COD					
63876	0,6	140	12	1	64005





NEW



COD					
63877	0,6	130	12	1	64005

NEW







COD					
63878	0,6	40	12	1	64005





NEW







CORTADORES / CUTTERS / CUTTERS / CUTTER / COLTELLI UNIVERSALI / X-ACTOS / РЕЗАКИ

COD					
69501	0,6	110	12	1	64005



COD					
69502	0,6	35	12	1	64005





COD					
69509	0,6	265	12	1	64005





CARGA AUTOMÁTICA CON 10 CUCHILLAS / AUTOMATIC LOAD WITH 10 BLADES / CHARGE AUTOMATIQUE AVEC 10 LAMES

CUCHILLA TRAPEZOIDAL / TRAPEZOIDAL BLADE / LAME TRAPEZOÏDALE / TRAPEZKLINGE / LAME TRAPEZIOIDALI / LÂMINA TRAPEZOIDAL / ТРАПЕЦЕВИДНОЕ ЛЕЗВИЕ

COD		
64005	60x19x0,6mm	5



CUCHILLA TIPO GANCHO / HOOK TYPE BLADE / LAME CROCHET / HAKENKLINGE / LAME TIPO GANCIO / LÂMINA TIPO GANCHO / ЛЕЗВИЕ КРЮЧКОВОГО ТИПА

COD		
63869	50x19x0,65mm	5

NEW



20 CORTE / CUTTING / OUTILS COUPANTS / SCHNEIDWERKZEUG / ARCHETTI / CORTE / РЕЗКА

CORTAFRÍOS / GOLD CHISEL / BEDANE / FLIESENMEISSEL / SCALPELLI ATAGLIENTE DIRITTO / ESCOPRO /
ЗУБИЛО

COD	HxL	gr.		
63178	15x160	150	6	1
63179	20x200	270		
63180	22x250	380		-



SET

COD	Composición / Composition	
63761	63178	15x160 mm
	63179	20x200 mm
	63180	22x250 mm



CINCEL CHAPISTA / EXTRA FLAT GOLD CHISEL / BURIN DE CARROSSIER / SCHLITZMEISSEL / SCALPELLO A
FREDDO PIATTO / ESCOPRO FINO / СВЕРХ ПЛОСКОЕ ЗУБИЛО

COD	L	A	gr.		
63472	204	27	240	6	1

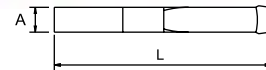

CINCEL / FLAT CHISEL / CISEAUX DE MAÇON / FLACHMEISSEL / SCALPELLI PER MURATORI / ESCOPRO /
ПЛОСКОЕ ЗУБИЛО

COD	L	A	B	gr.	
63309	200	23	16	300	6
63310	250	24		390	
63311	300	25		480	
63315		26	600		
63316	350	18	700		
63317	400	27	800		
63320	500	28	20	950	
63321			1200		

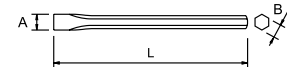

COD	L	A	B	gr.	
63326	200	23	16	450	6
63327	250	24		550	
62859	300	19		650	
63328		24	750		
63332	350	18	850		
63333	400	27	950		
63337	500	28	20	1100	
63338			1350		

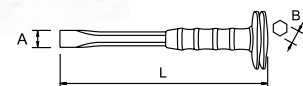

20

CORTE / CUTTING / OUTILS COUPANTS / SCHNEIDWERKZEUG / ARCHETTI / CORTE / РЕЗКА

PUNTERO / POINTED CHISEL / BROCHE / SPITZMEISSEL / SCALPELLI PER MURATORI / PONTEIRO / КОЛУЧНОЕ ЗУБИЛО

COD	L	A	gr.	
63339	200	16	300	6
63340	250		390	
63341	300	18	480	
63342			600	
63343	350	700		
63344	400	20	800	
63345			950	
63346	500	1200		



COD	L	A	gr.	
63347	200	16	450	6
63348	250		550	
63349	300	18	650	
63350	750			
63351	350	850		
63352	400	20	950	
63353			1100	
63354	500	1350		



CINCEL MECÁNICO / FLAT COLD CHISEL / BURIN MÉCANICIEN / FLACHMEISSEL / SCALPELLO PER MECCANICO / ESCOPRO MECÁNICO / ПЛОСКОЕ ЗУБИЛО

COD	L	A	B	C	gr.	
62847	100	11	7,0	12	65	12
62848	125	14	9,0	15	115	
62849	150	17	11	18	220	6
62850	200	20	12	21	280	
62851				290		
62852	220			24	300	
62853	250	23	13	25	320	
62854				28	460	
62855	300			26	480	
62856	400	26		29	500	
62857				550		
62858	500			30	550	

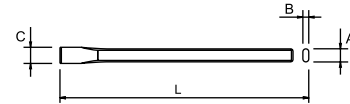

COD	L	A	B	C	gr.	
62862	200	20	12	21	330	6
62863	340					
62864	220	23	13	24	350	
62865	250			25	370	
62866	300	26	13	28	500	
62867				29	550	
62868	400	26		30	600	
62869	500					
62870	500					

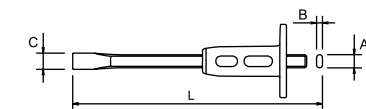

20

CORTE / CUTTING / OUTILS COUPANTS / SCHNEIDWERKZEUG / ARCHETTI / CORTE / РЕЗКА

BURIL PLANO / CROSSCUT CHISEL / BÉDANE PLATE / KREUZSCHNITT MEISSEL / BULINO PIATTO / BURIL PLANO / ЗУБИЛО ДЛЯ ВЫРУБКИ

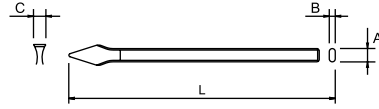

COD	L	A	B	C	gr.	
62871	125	14	9,0	5,0	90	6
62872	150	16	10	6,0	150	
62873	175	17	11	7,0	240	
62874	200	20	12	8,0	280	
62875	250	23	13	9,0	300	
62876	300				310	

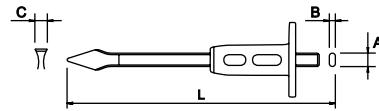

COD	L	A	B	C	gr.	
62880	200	20	12	8,0	330	6
62881	250				350	
62882	300	23	13	9,0	360	

CINCEL PARA LADRILLOS / BOLSTER CHISEL / CISEAUX À BRIQUES / FUGENMEISSEL / SCALPELLI DA PIASTRELLISTA / ESCOPRO PARA LADRILHOS / ЛОПАТОЧНОЕ ЗУБИЛО

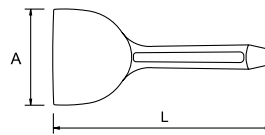

COD	L	A	gr.	
63181	220	60	350	6
63182	240	75	700	
63191		100	900	

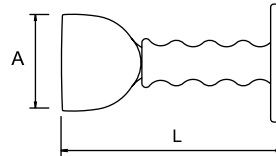

COD	L	A	gr.	
63183	220	60	410	5
63184		75	750	
63192	240	100	1050	

20**CORTE / CUTTING / OUTILS COUPANTS / SCHNEIDWERKZEUG / ARCHETTI /
CORTE / РЕЗКА****CINGELES, BOTADORES Y GRANETES / CHISELS AND PUNCHES / BURINS, CHASSE-GOUPILLES ET
POINTEAUX / MEISSEL UND DURCHSCHLÄGE / SCALPELLI E PUNZONI / ESCOPROS, SACA-TROÇOS E
PUNÇÕES / ЗУБИЛА И ПРОБОЙНИКИ**

COD	Composición / Composition	gr.
A: 69953	62847 Cincel mecánico / Cold chisel: 12x11x100mm	700
	62848 Cincel mecánico / Cold chisel: 15x14x125mm	
	63398 Botador cilíndrico / Pin punch: 6x10x150mm	
	63396 Botador cilíndrico / Pin punch: 4x8x150mm	
	63436 Botador cónico / Taper punch: 3x10x120mm	
63416 Granete / Center punch: 3x8x100mm		
B: 69954	62847 Cincel mecánico / Cold chisel: 12x11x100mm	700
	62848 Cincel mecánico / Cold chisel: 15x14x125mm	
	62871 Butil plano / Crosscut chisel: 5x14x125	
	63396 Botador cilíndrico / Pin punch: 4x8x150mm	
	63436 Botador cónico / Taper punch: 3x10x120mm	
	63416 Granete / Center punch: 3x8x100mm	

EGA *Master* S.A.
ART IN INNOVATION

20 CORTE / CUTTING / OUTILS COUPANTS / SCHNEIDWERKZEUG / ARCHETTI / CORTE / РЕЗКА

HACHAS / AXES / HACHES / ÄXTE / ASCIA / MACHADOS / ТОПОРЫ

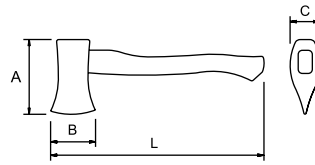

COD	L	A	B	C	Kg.	
67232	450	145		22	0,8	6
67233	600	160	100	23	1,0	
67234	700	175	110	27	1,2	
67235	800	185	120		1,5	
67236		195	130	28	2,0	

MAZA CUÑA / WEDGE HAMMER / MASSE COIN / SPALTHAMMER / MARTELLO A CUNEO / MALHOS / ТОПОР КОЛУН

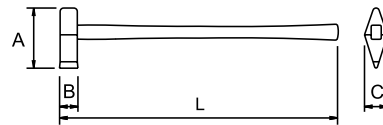

COD	L	A	B	C	Kg.	
67237	900	200	65	55	3,0	6

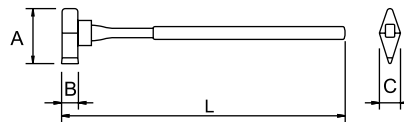

COD	L	A	B	C	Kg.	
67238	900	200	65	55	3,0	6

FIBRA DE VIDRIO / FIBERGLASS / FIBRE DE VERRE / FIBERGLASS / FIBRA DI VETRO /
FIBRA DE VIDRO / ФИБЕРГЛАСС

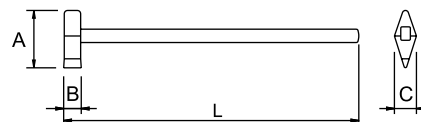

COD	L	A	B	C	Kg.	
67239	900	210	90	50	2,5	6

20 CORTE / CUTTING / OUTILS COUPANTS / SCHNEIDWERKZEUG / ARCHETTI / CORTE / РЕЗКА

HACHA BOMBERO / FIREMAN TYPE AXE / HACHE POUR POMPIERS / FEUERWEHRAXT / ASCIA TIPO PER POMPIERI / MACHADO DE BOMBEIRO / ТОПОР ПОЖАРНОГО ТИПА

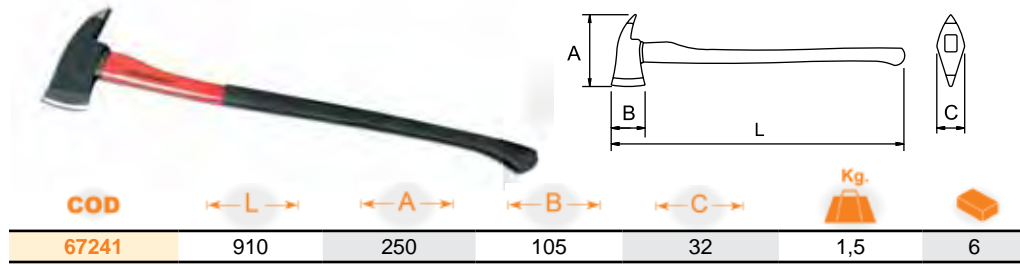
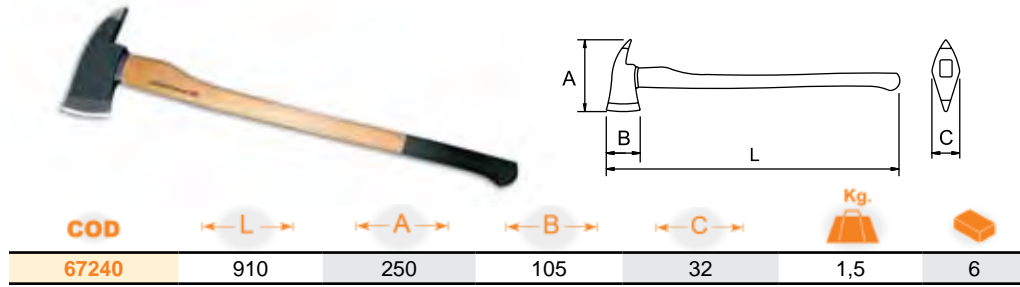

FIBRA DE VIDRIO / FIBERGLASS / FIBRE DE VERRE / FIBERGLASS / FIBRA DI VETRO /
FIBRA DE VIDRO / ФИБЕРГЛАСС

HACHA AZADA / HOE AXE / HACHE HOUE / WIEDEHOPFHACHE / ACE PER ZAPPA / MACHADO ENXADA /
ТОПОР МОТЫГА

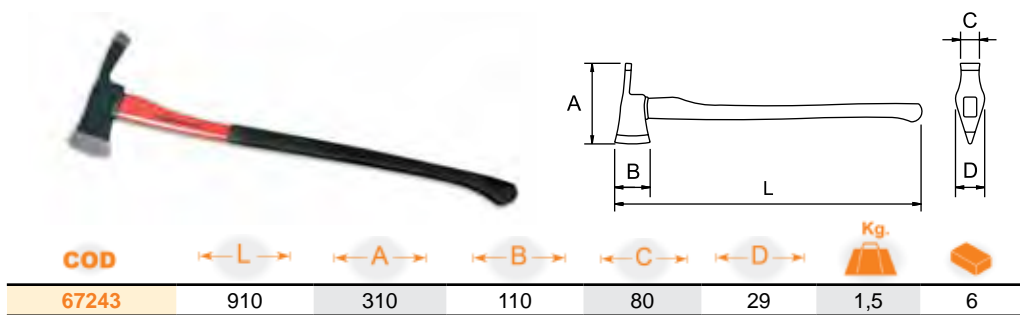
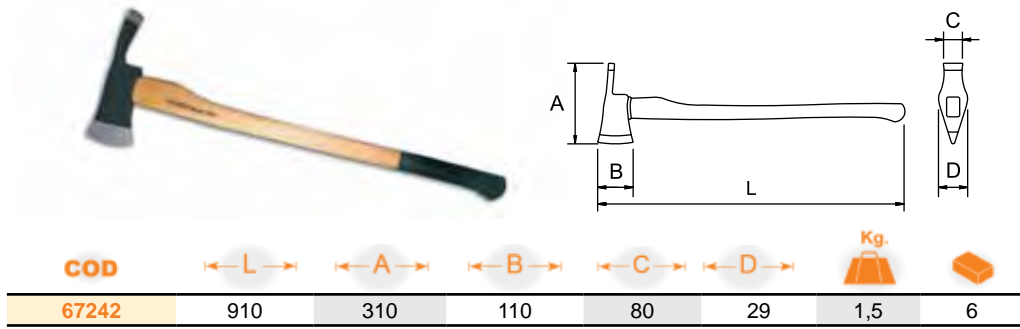

FIBRA DE VIDRIO / FIBERGLASS / FIBRE DE VERRE / FIBERGLASS / FIBRA DI VETRO /
FIBRA DE VIDRO / ФИБЕРГЛАСС

MACHETE / MACHET / MACHETT / MESSER / MACETE / CATANA / МАЧЕТЫ

COD	L	gr.	
67255	21"	550	48



20

CORTE / CUTTING / OUTILS COUPANTS / SCHNEIDWERKZEUG / ARCHETTI / CORTE / РЕЗКА

SIERRAS DE CORONA BIMETAL / BI-METAL HOLE SAWS / SCIES CLOCHES BI-MÉTAL / BIMETALL LOCHSÄGE / SEGHE A TAZZA BI-METAL / SERRAS CRANEANAS BI-METÁLICAS / БИМЕТАЛЛИЧЕСКИЕ КОРОНКИ

HSS BI-METAL

4/6 TPI

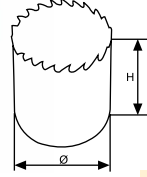



r.p.m.

COD	Ø (mm)	Ø (inch.)	H (mm)	r.p.m.	r.p.m.					
					Acero dulce Mild steel	Inox	Fundición Casting	Aluminio Aluminium	Latón Brass	Madera Wood
64550	14mm	9/16"	54	64601	620	300	400	900	790	3000
64551	16mm	5/8"			545	260	360	810	735	
64552	17mm	11/16"			510	250	340	770	690	
64553	19mm	3/4"			460	220	300	685	620	
64664	20mm	-			430	210	290	650	590	
64554	21mm	13/16"			415	200	275	620	560	
64555	22mm	7/8"			395	190	260	590	535	
64556	24mm	15/16"			360	175	240	540	490	
64557	25mm	1"			350	175	235	525	470	
64558	27mm	1.1/16"			50	64601	320	160	215	
64559	28mm	-	310	150			205	450	405	
64560	29mm	1.1/8"	300	145			200	430	390	
64561	30mm	1.13/16"	290	140			190	410	370	
64562	32mm	1.1/4"	270	130			180	390	355	
64563	33mm	1.5/16"	265	125			175	370	335	
64564	35mm	1.3/8"	250	120			165	350	320	
64565	37mm	1.7/16"	235	115			155	340	310	
64566	38mm	1.1/2"	230	110			150	325	295	
64567	40mm	1.9/16"	215	105			145	315	285	2400
64568	41mm	1.5/8"	210	100	140	300	275			
64569	43mm	1.11/16"	200	95	135	295	270			
64570	44mm	13/4"	195	95	130	280	255			
64571	46mm	1.13/16"	190	90	125	270	245			
64572	48mm	1.7/8"	180	90	120	255	230			
64573	50mm	2"	170	85	115	245	220			
64574	50mm	1.1/16"	165	80	110	240	215			
64575	55mm	2.1/8"	160	75	105	230	205			
64576	55mm	2.1/4"	150	75	100	220	200			
64577	60mm	2.5/16"	145	70	95	215	195			
64578	60mm	2.3/8"	140	70	95	205	185			
64579	65mm	2.1/2"	44	64602	135	65	200	180	2000	
64580	65mm	2.9/16"					195	175		
64581	67mm	2.5/8"					130	190		170
64582	70mm	2.3/4"					125	185		165
64583	73mm	2.7/8"					120	180		160
64584	76mm	3"					115	170		150
64585	79mm	3.1/8"					110	165		145
64586	83mm	3.1/4"					105	155		140
64587	86mm	3.3/8"					100	150		135
64588	89mm	3.1/2"					95	145		130
64589	92mm	3.5/8"	40	64602	95	45	140	125	1500	
64590	95mm	3.3/4"					90	135		125
64591	98mm	3.7/8"					88	130		120
64592	102mm	4"					85	125		110
64593	105mm	4.1/8"					83	120		110
64594	108mm	4.1/4"					80	115		105
64595	110mm	4.5/16"					78	115		105
64596	114mm	4.1/2"					76	110		100
64597	121mm	4.3/4"					72	110		100
64598	127mm	5"					68	100		90
64599	140mm	5.1/2"	62	90	85					
64600	152mm	6"	55	85	75	700				

20

CORTE / CUTTING / OUTILS COUPANTS / SCHNEIDWERKZEUG / ARCHETTI / CORTE / РЕЗКА

HUSILLO / ARBOR / VERRIN / HALTER / SUPPORTO / FUSO / ОПАВКА

COD	Ø (mm)		
64601	14-30mm	3/8" - 9,52	1
64602	32-152mm	7/16" - 11,1	1







CONECTOR ADAPTADOR ROSCA / THREAD CONNECTION ADPTER / CONNECTEUR ADAPTATEUR DE FILETAGE / ADAPTER FÜR GEWINDE / ADDATTATORE CONNETTORE PER FILIERA / ADAPTADOR DE ROSCA / РЕЗЬБОВОЙ АДАПТОР

COD			
64612	20	10	1





ALARGADERA / EXTENSION / RALLONGE / VERLÄNGERUNG / PROLUNGA / EXTENÇÃO / УДЛИНИТЕЛЬ

COD		L			
64613	7/16" - 11,1	300	290	10	1







BROCA / DRILL / FORET CONIQUE / BOHRER / PUNTE / BROCA / СБЕРИО





COD				
64614	75	15	10	1







SETS

COD	Ø (mm)				
64615	19-22-35 38-44-67	64601-64602	64612	1500	1



COD	Ø (mm)				
64651	16-21-25 32-40-51	64601-64602	64612	1500	1



COD	Ø (mm)					
64616	19-22-29-35-38 44-51-57-64-67	64601-64602	64612	64613	300	1



20

CORTE / CUTTING / OUTILS COUPANTS / SCHNEIDWERKZEUG / ARCHETTI / CORTE / РЕЗКА

BROCA ESCALONADA / STEP DRILL / FORET ÉTAGÉ / SPIRALBOHRER / PUNTA SCANALATA / BROCA ESCALONADA / СТУПЕНЧАТОЕ СВЕРЛО

COD	Ø (mm)	gr.		
64617	4-12	25	1	1
64618	4-20	60		
64619	4-30	180		

SET

COD	Ø (mm)	gr.	
64620	4-12	1	1
	4-20		
	4-30		



EXTRACTORES DE TORNILLOS / SCREW STRACTORS / EXTRACTEUR DE VIS / SCHRAUBENAUSDREHER / ESTRATTORI / EXTRACTORES DE PERNOS / РЕЗЬБОВЫЕ ЭКСТРАКТОРЫ

COD	M	L	A	B	D	gr.
61583	3-6	50	2,6	3,9	2,5	5
61584	6-8	55	3,0	4,3	3,0	10
61585	8-11	65	4,0	6,5	4,5	20
61586	11-14	75	4,5	7,5	6,0	30
61587	14-18	85	7,0	11	8,0	50
61588	18-25	90	9,0	15	11	100
61589	25-35	95	9,5	19	14	150
61590	>35	100	14	24	20	200

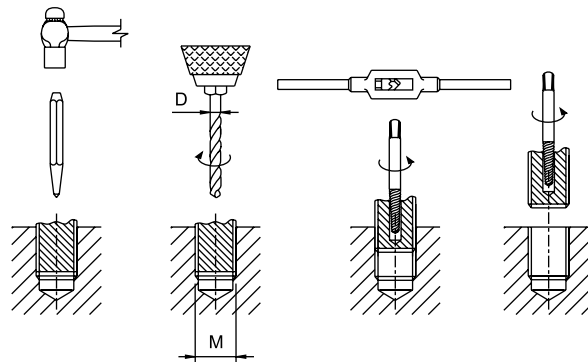
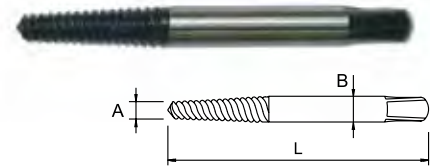

SET

COD	Composición / Composition	pcs.	gr.
61591	61583, 61584, 61585 61586, 61587	5	100
61592	61583, 61584, 61585 61586, 61587, 61588	6	200
61593	61583, 61584, 61585 61586, 61587, 61588 61589, 61590	8	750



20

CORTE / CUTTING / OUTILS COUPANTS / SCHNEIDWERKZEUG / ARCHETTI / CORTE / РЕЗКА

SACABOCADOS / HOLLOW PUNCHES / EMPORTE PIÈCES / HENKELLOCHEISEN / SACABOCADOS / SACA BOCADOS / ВЫРУБАТЕЛИ ПРОКЛАДок

COD	PCS	O.D (mm)	gr.	
64670	10	5-6-8-10-12,5-16-20-25-32	900	1



COD	Ø (mm)	L mm	gr.	
64671	5	27	15	10
64672	6			
64673	8			
64674	10			
64675	12,5			
64676	16			
64677	20			
64678	25			
64679	32			



COD	Ø (mm)	gr.	
64680	5-32	250	1



20**CORTE / CUTTING / OUTILS COUPANTS / SCHNEIDWERKZEUG / ARCHETTI /
CORTE / РЕЗКА****CIZALLA CORTACHAPAS / METAL PLATE CUTTER / CISAILLE COUPE TOLE / SCHNEIDER
FÜR METALLPLATTE / CESCOIA TAGLIA LAMIERA / GUILHOTINA CORTA CHAPAS /
НОЖНИЦЫ ПО МЕТАЛЛУ**

COD	V	W	Kg.
60269	230V	660W	3,5

Especificaciones técnicas / Technical specification / Détails techniques

Para chapas de acero, acero inoxidable, aluminio, cobre... / For steel, stainless steel, aluminium, copper... Pour de la tôle d'acier, d'Inox,d'Aluminium, de cuivre...	●
Espesores máximos de chapa / Plate maximum thickness / Epaisseurs maximum de tôle	
800N/mm2	1,5
600N/mm2	2,5
400N/mm2	3,2
200N/mm2	4
Mínimo radio de corte curvo / Minimum radio of curved cutting / Rayon minimum de courbure en coupure	500mm
Velocidad cuchillas / Blade Speed / Vitesse de lame	1600spm
Dimensiones generales / Overall dimensions / Dimensions générales	200x90x250mm
Longitud de cable / Wire lenght / Longueur de câble	2,5m
Juego de cuchillas / Blade set / Jeu de lames	85200
Llave allen / Allen Key / Clé mâle	4mm
Galga de calibración / Calibration Gage / Jauge	●
Empuñadura de puente / Bridge type hilt / Manche en U	●
Cuchillas reversibles / Reversible blades / Lames réversibles	●
Cuchillas reafilables / Resharpenable blades / Lames affutables	●
Cuchillas ajustables / Adjustable blades / Lames ajustables	●
Buena visión de línea de corte / Good view of cutting line / Bonne vision de ligne de coupe	●
Fácil manejo para zurdos / Easy use for left-handed people / Utilisation facile par les sourds	●



*G12: GARANTIA 12 MESES / 12 MONTHS OF WARRANTY / 12 MOIS DE GARANTIE / 12 MONATE GARANTIE / 12 MAANDEN GARANTIE / 12 MESI DI GARANZIA

**353**

20**CORTE / CUTTING / OUTILS COUPANTS / SCHNEIDWERKZEUG / ARCHETTI /
CORTE / РЕЗКА****CORTACHAPAS / PLATE CUTTER / COUPE TOLE / METALLPLATTE SCHNEIDER /
TAGLIALAMIERA / CORTA CHAPAS / НОЖНИЦЫ ПО МЕТАЛЛУ**

COD	V	W	Kg.
60126	230V	560W	3
60127	110V		

Especificaciones técnicas / Technical specification / Détails techniques

Taladro incluido / <i>Included drill machine / Perceuse inclus</i>	●
Estuche de aluminio / <i>Aluminium case / Etui en aluminium</i>	●
Cabezas de corte a izquierdas / <i>Left cutting heads / Têtes de coupe à gauche</i>	2 pcs
Cabezas de corte a derechas / <i>Right cutting heads / Têtes de coupe à droite</i>	
Max. espesor chapa acero / <i>Steel max. thickness / Epaisseur maximum tôle en acier</i>	1,5mm
Max. espesor chapa acero INOX / <i>Stainless steel max. thickness / Epaisseur maximum tole en INOX</i>	1,0mm

